

PLAN VIEW

SCALE: 1/2" = 1'-0"

1

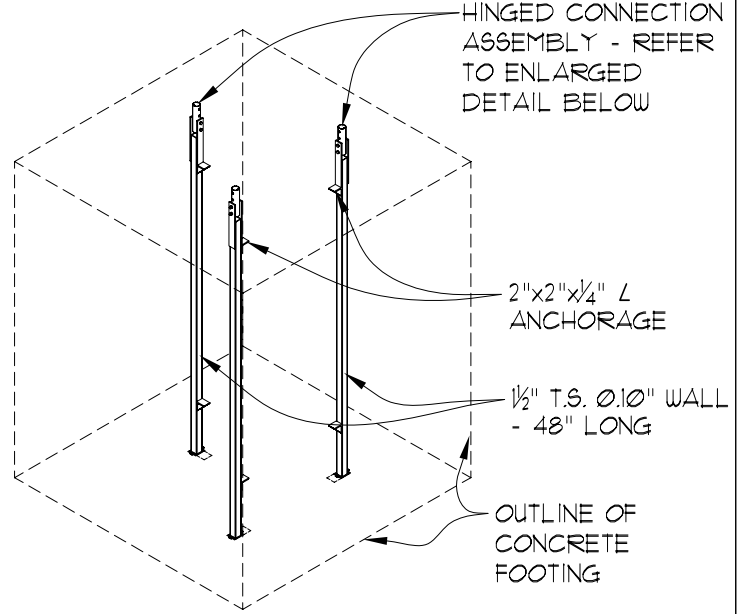

ISOMETRIC

SCALE: N.T.S.

3

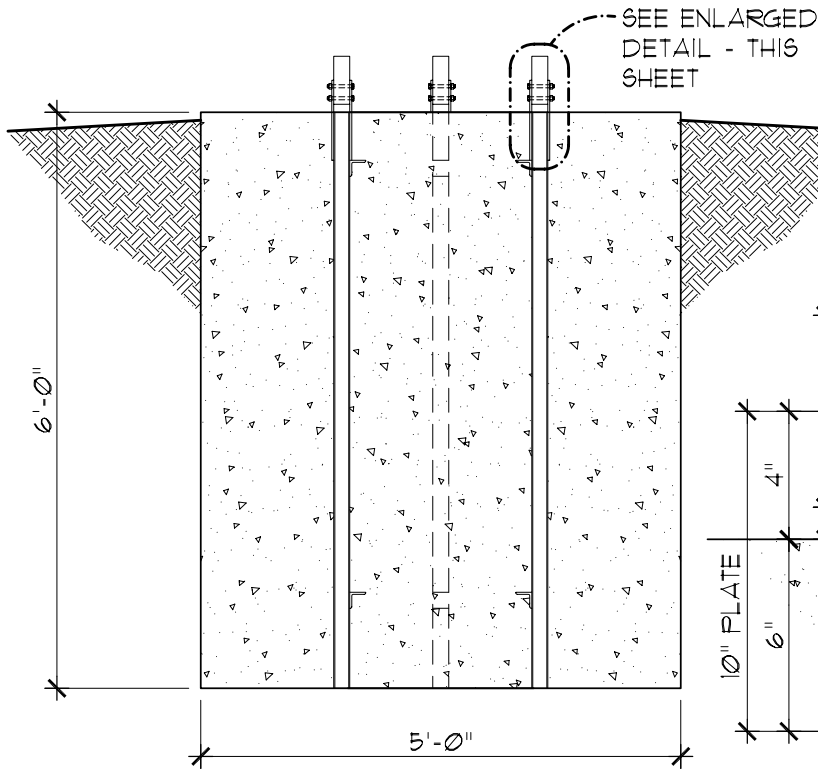

ELEVATION

SCALE: 1/2" = 1'-0"

2

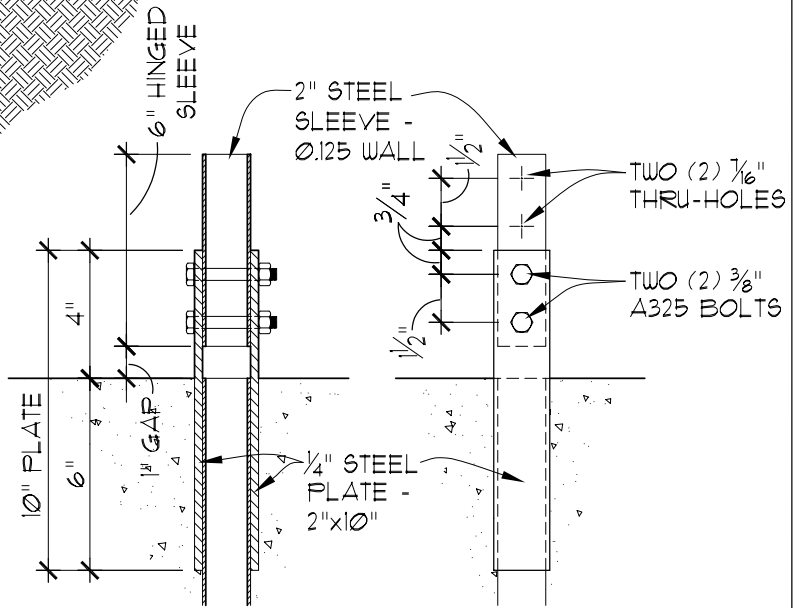

BASE FOOTING



UNIVERSAL TOWERS
 A DIVISION OF
 UNIVERSAL MANUFACTURING CORP.
 43900 GROESBECK HWY.
 CLINTON TOWNSHIP, MI 48036
 PH: (586) 463-2560
 FAX: (586) 463-2964

JOB NO.:

COMPONENT:

B-30